

Article number: 390204402042716

Description: Worm Gear with Torque Limiter
VF 44-L1-F-20-P71B5

Measures

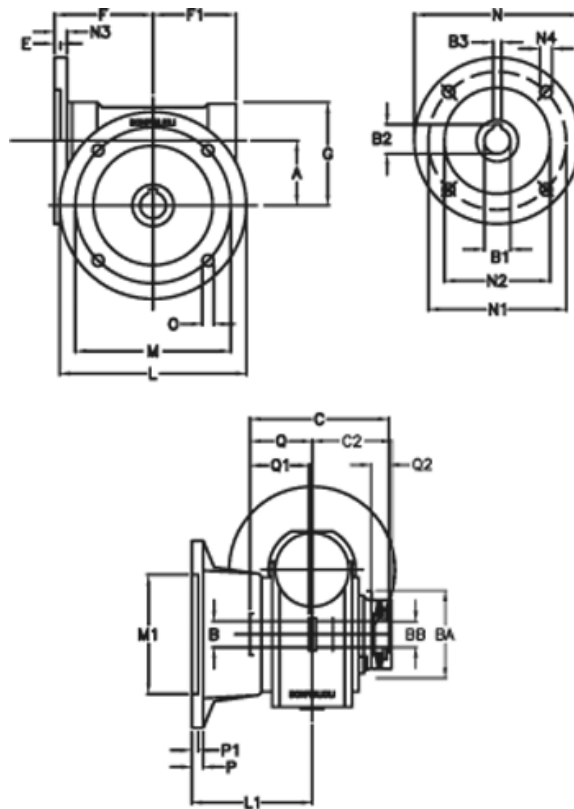

a = 44.60	C2 = 48	m = 87	P = 9
B = 18	Description = VF 44F-xx-71B5	M1 = 60	P1 = 7
B1 E7 = 14	E = 2.0	N = 160	Q = 32.0
B2 = 16.3	F = 65	N1 = 130	Q1 = 32
B3 H9 = 5	F1 = 54	N2 = 110	Q2 = 12
BA = 40	g = 71	N3 = 10.5	
BB H7 = 11	L = 110	N4 = 9.5	
C = 79	L1 = 60.5	O = 8.5	